

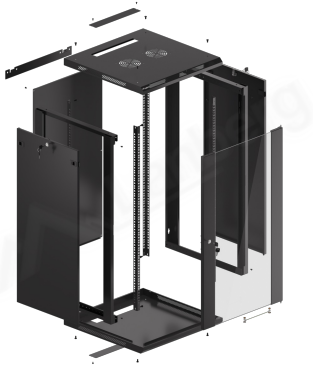

WF01-6622-10B

RACK CABINET 19" WALL-MOUNT



PRODUCT FEATURES:

- Made of high quality rolled steel
- Designed for self-assembly (FLAT PACK)
- Equipped with numbered mounting rails
- Has the ability to mount optional wheels
- Included wall mounting bracket
- Cable entry panel: top and bottom

PRODUCT SPECIFICATION:

Type of cabinet	Wall mount
Size	19"
ICT Height	22 U
Assembly type	Self-assembly
Weatherproof rating	IP20
Working depth	529,5 mm
Standard	ANSI/EIA RS-310-D, DIN 41491/PART 1, DIN 41494/PART 7, ETSI, IEC297-2:1982
Maximum static load	60 kg
Front door types	Temper glass
Slot amount for fans	2
Colour	Black
Front door thickness	5 mm
Upper & lower panel thickness	1,2 mm
Side panel thickness	1 mm
Mounting rails thickness	1,5 mm
Other elements sheet thickness	1,2 mm
Depth	600 mm
Weight	35 kg
Included Accessories	User guide, Grounding cable, M6 screws, Mounting bracket, Front lock, Side locks, Set of assembly elements

